



Product Portfolio & Capabilities Statement

January 9, 2025

Tersus Environmental, LLC
+1 919-453-5577 • info@tersusenv.com
tersusenv.com • surbec.com



Tersus Environmental, LLC
Product Portfolio & Capabilities Statement
Table of Contents

1.	Summary	1
2.	Company Background and Technology Development History	1
3.	Products and Services	3
3.1	Products by Treatment Category	3
3.1.1	Enhanced Reductive Bioremediation	3
3.1.2	In Situ Chemical Reduction	5
3.1.3	Surfactant-Enhanced Aquifer Remediation (SEAR).....	6
3.1.4	In Situ Chemical Oxidation (ISCO)	6
3.1.5	Enhanced Anaerobic Oxidative Bioremediation	7
3.1.6	In Situ Sorption and Biodegradation (NutriBind®)	8
3.1.7	Enhanced Aerobic Biodegradation.....	8
3.1.8	Nutrients and Microbes	9
3.2	Services.....	10
3.2.1	Design and Implementation Support.....	10
3.2.2	Environmental Forensics and Performance Monitoring.....	10
3.2.3	SEAR Treatability Studies	10
4.	Product Distribution Centers / Warehouse Facilities	11
5.	Project Showcases: A Track Record of Success.....	11
6.	Leadership Team: Background and Experience	12
7.	Intellectual Property (Tersus Assigned Patents and Trademarks).....	15
8.	Insurance.....	16
9.	Safety	16
10.	Working with Us.....	17
11.	Contact.....	18

Appendices

- A Case Studies



Tersus Environmental, LLC Product Portfolio & Capabilities Statement

About Tersus Environmental

Tersus Environmental, founded in 2011, is dedicated to researching, developing, and bringing to market innovative soil and groundwater remediation solutions. We leverage strong partnerships with universities and professionals to stay at the forefront of technological advancements for contaminated sites. Our proven technologies empower our clients to reduce uncertainty, mitigate risks, and attain cost-effective results.

Our commitment extends to providing exceptional customer service on a daily basis. Instead of concentrating on a singular technology, Tersus Environmental tailors solutions to meet the unique needs of each site. We eagerly anticipate the opportunity to assist you in crafting an optimally cost-effective remediation approach.

Company Information

- Small Business
- NAICS: 562910 (750 employees)
- CAGE Code: 70SW7
- DUNS: 03-778-7719
- SAM Unique Entity ID: D53BSVAMRJA7

Groundwater and Soil Remediation of:

- Chlorinated Solvents
- Petroleum Hydrocarbons
- NAPLs
- Pesticides
- Metals

1. Summary

Tersus Environmental (Tersus) is a reputable technology company in the groundwater and soil remediation sector, known for its financial stability, patents, proprietary formulations, and customer service. With a national presence in the U.S., including both coasts, and a vast client database, Tersus operates from four strategically located third-party logistics (3PL) warehousing facilities. The team consists of skilled professionals in engineering (chemical and environmental), sales, logistics, accounting, and advisory roles.

2. Company Background and Technology Development History

Tersus is recognized worldwide for the development and commercialization of technology-based solutions for the *in situ* treatment of groundwater and soil contamination. Tersus started in 2011 focusing on the commercialization of Gas Infusion Technology for bioremediation. The company expanded to become a leading provider of amendments, technologies, and services specific to groundwater and soil remediation.

To keep pace with the demand for our effective solutions, we began opening product distribution centers. Presently, Tersus operates strategically located distribution centers in California, Illinois, North Carolina, Wisconsin, and France, providing clients with convenient access to our effective solutions.

Technology Commercialization Timeline

In 2011, Tersus commercialized EDS-ER™ the first and most widely used water-mixable vegetable oil based organic substrate to provide a lasting source of carbon and hydrogen for enhanced reductive dechlorination and other bioremediation processes. When mixed with water, EDS-ER™ spontaneously becomes an emulsified vegetable oil (EVO).

Product Portfolio & Capabilities Statement

Also in 2011, Tersus commercialized Nutrimens[®], an all-natural bio-fermentation product produced during the fermentation of an unmodified strain of botanical classification *Saccharomyces cerevisiae*. Nutrimens[®] is designed to enhance the kinetics and efficiency of microbial systems. Another advantage of Nutrimens[®] is that it also provides a source of soluble donor, it contains over 12% Total Carbon and maintains circumneutral pH.

In 2014, Surbec Environmental, the leading developer of surfactant technologies for environmental remediation, and Tersus entered into a Distribution Agreement. Surbec's proprietary anionic surfactant formulations have the unique ability to selectively desorb and liberate sorbed organic liquid contaminant (non-aqueous phase liquids, or NAPLs) from soil and fractured bedrock surfaces. Subsequently, Tersus became the exclusive owner of Surbec's proprietary formulations, with all patents assigned to our company. Today, Tersus uses the Surbec domain for its online store.

R&D Efforts

Further strengthening the company's intellectual property coverage for the diverse selection of products and technologies addressing the remediation of contaminated soils and aquifers, U.S. Patent and Trademark Office (USPTO) issued patents to Tersus in 2021 and 2022 related to *In Situ* Chemical Reduction (ISCR). Patent No. 11,123,779 B2 (the '779 patent) was issued in 2021 and Patent 11,491,522 B2 (the '522 patent) was issued in 2022.

The '779 claims are generally directed towards a method for supplying a mixture comprising ferrous sulfide and zero-valent metal particle reactants into soil pathways to biologically react with dissolved contaminants in groundwater. Further, an organic hydrogen donor is supplied into the soil-pathways to produce anaerobic-conditions to cause indigenous anaerobic bacteria to biodegrade residual concentrations of the contaminants. The claims are also generally directed towards a chemical composition comprising vegetable oil, an oil thickening agent, and a surfactant forming suspension networks for ferrous sulfide and zero-valent metal particle reactants, wherein said suspension network comprises ferrous sulfide and zero-valent metal particles encapsulated within a liquid membrane formed of the vegetable oil.

The '522 patent claims are generally directed towards a zero-valent metal particle suspension for the remediation of soil and groundwater. The claims are also generally directed towards a chemical composition comprising vegetable oil, an oil thickening agent, a surfactant, and a particulate zero-valent metal forming a zero-valent metal suspension in a non-aqueous phase, wherein said suspension network comprises zero-valent metal particles encapsulated within a liquid membrane formed of the vegetable oil.

Introduction of EDS-Advanced™

In 2023, the USPTO issued Tersus Patent No. US 11,577,231 B2 (the '231 patent) titled "Enhanced Reduction Bioremediation Method Using In-Situ Alcoholysis." The '231 patent claims (commercialized as EDS-Advanced™) are generally directed towards, but not limited to, transesterification of vegetable oils to improve formation and distribution of slowly fermenting and soluble electron donors that are essential to anaerobic reductive bioremediation within the environmental medium.

Surfactant specialists at Tersus designed EDS-Advanced™ (the '231 patent) to overcome two of the main challenges associated with EVO injection: poor fatty acid subsurface distribution and biofouling. EDS-

Product Portfolio & Capabilities Statement

Advanced™ is optimized to distribute widely upon injection. By reacting EDS-ER™, a water-mixable vegetable oil based organic substrate, *in situ* with EDS-Activator™, a homogeneous alkaline catalyst, the fatty acids of the triglyceride molecule are cleaved to form fatty acid alkyl esters, carboxylic acids, and glycerol. This allows for high volume applications with fewer injection points. Field work on projects throughout the U.S. and Australia for the treatment of halogenated volatile organic compounds has demonstrated that EDS-Advanced™ injections provide far greater performance than traditional EVO injections. Clients have reported a remarkable over 90% reduction in contaminant mass within the initial 90 days following EDS-Advanced™ injection. Beyond this initial period, the slow fermentation of electron donors continues to supply organic carbon and hydrogen for the ongoing mineralization of remaining chlorinated solvents.

The '231 claims include the use of heat. Today Tersus is developing and commercializing technologies for heat enhanced catalyzed reductive bioremediation. Current R&D efforts are focused on developing cost-effective methods for applying heat. Adding heat further enhances the process as the reaction temperature significantly influences the transesterification reaction. By heating the injection fluids prior to emplacement or applying heat to the process, the time needed for the *in situ* transesterification reactions drops to minutes / hours from the expected months. Heat also enhances the degradation rates as the optimal range is 25-30°C for neutrophilic, strictly hydrogenotrophic Dhc strains (Löffler et al. 2013). This technology offers the performance of *in situ* thermal remediation (ISTR) for a chlorinated site using ERH or TCH at a fraction of the cost.

3. Products and Services

In the realm of contaminated site remediation, a wide array of potential solutions exists. Tersus provides a versatile range of products and technologies, avoiding a singular focus on one method. Instead, Tersus tailors the right solution to meet the specific needs of your site. Our established technologies empower clients to diminish uncertainty, mitigate risks, and attain cost-effective results. Rest assured, we have comprehensive coverage for every zone of your plume!

3.1 Products by Treatment Category

This section highlights some of our most popular site remediation solutions by treatment category and highlights some key points about each one.

3.1.1 Enhanced Reductive Bioremediation

Anaerobic reductive bioremediation involves introducing biologically available organic amendments, known as organic substrates or electron donors, into groundwater. This process aims to create and sustain anoxic conditions by depleting oxygen through aerobic respiration, as well as other electron acceptors, during the biodegradation process. Through the fermentation reactions that generate hydrogen, anaerobic reductive bioremediation facilitates the bioreduction of oxidized contaminants, particularly chlorinated solvents. In this anaerobic environment, chlorinated compounds act as electron acceptors and undergo reductive dechlorination when paired with an electron donor (USEPA, 2013).

Tersus has developed an advanced suite of products aimed at optimizing *in situ* remediation processes. Central to our commitment is EDS-Advanced™, a catalyzed enhanced bioremediation technology anchored by the '231 patent. This cutting-edge solution comprises various components, each

Product Portfolio & Capabilities Statement

meticulously crafted to address the complexities of contaminated environments and propel the efficacy of bioremediation. Let's delve into the detailed description of our featured products within the EDS-Advanced™ portfolio.

EDS-Advanced™

EDS-Advanced™ is a catalyzed enhanced bioremediation technology that includes:

- EDS-ER™, a long-lasting electron donor, revolutionized the field when released in 2011. As the first water-mixable vegetable oil-based organic substrate, it provides a sustained source of carbon and hydrogen for enhanced reductive dechlorination and other bioremediation processes. Shipped as a 100% fermentable substrate concentrate, EDS-ER™ creates optimal conditions for anaerobic remediation, consisting of refined, bleached, and deodorized soybean oil and surfactants (TASK™ MicroEVO Self-Emulsifier). When mixed with water, EDS-ER™ spontaneously transforms into an emulsified vegetable oil (EVO), see YouTube video at <https://youtu.be/9p-5dBeKBcE>.
- EDS-Substrate Shuttle™: This water-miscible solvent efficiently dissolves the vegetable oil, creating a solution with the distribution properties of a soluble electron donor.
- EDS-Activator™: A homogeneous alkaline catalyst that promotes the formation of fatty acid alkyl esters, carboxylic acid salts, and glycerol (EDS-QR™).
- EDS-ME™: An EtOH/MeOH Alcohol blend consisting of Ethanol, Methanol, and n-Propyl Alcohol.
- Nutrimens®, a natural fermentation product derived from the anaerobic fermentation of *Saccharomyces cerevisiae*. It provides reduced carbon and a range of beneficial vitamins, minerals, and metabolites, enhancing microbial activity for efficient bioremediation. Nutrimens® increases removal rates of priority pollutants while aiding in maintaining circumneutral pH. Notably, Tersus' Nutrimens® product stimulates fermentation, resulting in increased volatile fatty acid (VFA) production, with minimal impact on pH.

Field Prepared EVO

For larger EVO projects requiring bulk deliveries of electron donors, you can significantly reduce both your project costs and carbon footprint by utilizing TASK™ MicroEVO Self-Emulsifier. This optimized surfactant blend facilitates the creation of stable vegetable oil-water emulsions. The self-emulsifier is specifically engineered to undergo spontaneous phase inversion into soybean oil, simplifying field mixing. Opting for locally sourced soybean oil further contributes to substantial cost savings.

Tersus will handle the shipment of the emulsifying agents to your site and the delivery of locally available soybean oil. Purchasing the oil directly from a processing plant our local tank farm not only ensures cost-effectiveness but also leads to substantial reductions in shipping expenses. The EDS-ER™ product can be effortlessly prepared in the field by adding TASK™ MicroEVO Self-Emulsifier to a

Reduce your EVO bioremediation project cost and carbon footprint with TASK™ MicroEVO Self-Emulsifier.



Product Portfolio & Capabilities Statement

storage tank, followed by the addition of soybean oil. Upon introducing water to the field-prepared EDS-ER™, the mixture will spontaneously form a stable microscale emulsion, ready for injection. Your field crew can inject the formulated EVO directly or choose to further dilute it based on a predetermined ratio.

3.1.2 *In Situ Chemical Reduction*

In Situ Chemical Reduction (ISCR) stands out as an innovative environmental technique employed for soil and groundwater remediation. This method involves introducing a reductant or reductant-generating material into the subsurface to diminish the concentrations of targeted environmental contaminants to acceptable levels. Zero-Valent Iron (ZVI) stands as the primary agent, widely used for remediating toxic organohalides, such as chlorinated ethenes and ethanes, pesticides, energetic compounds, and certain metals and metalloids, converting them into harmless end products (ITRC, 2011). Tersus spearheads advancements in ISCR with a sophisticated suite of products designed to optimize remediation outcomes. Our advanced suite of ISCR products demonstrate unparalleled efficacy in soil and groundwater remediation include:

- **EDS-ZVI™:** Delivered as a two-part system, EDS-ZVI™ consists of a less than 5-micron sulfonated ZVI colloidal suspension (mZVI) and a water-mixable vegetable oil-based organic substrate (EDS-ER). This innovative product presents colloidal, sulfonated zero-valent iron particles suspended in glycerol, eliminating the necessity for on-site mixing with guar or thickening agents. Co-injecting the two-part system (mZVI and EDS-ER™) and diluting it with water results in a mixture that is easily injectable through direct push or permanent injection wells, without the mandatory requirement of pneumatic or hydraulic fracturing.
- **ZVI-ironGEL™:** A 45% ZVI colloidal suspension with a mean particle size of less than 10-micron, ZVI-ironGEL™ is optimized for injection at a 30 g/L ZVI concentration. The product incorporates environmentally friendly polymers engineered to create a viscoelastic gel, exhibiting shear-thinning behavior upon dilution with water. This gel ensures high colloidal stability, good injectability, and enhanced distribution in the subsurface, as showcased in our YouTube video (<https://youtu.be/I3w6Evd92yE?si=qj7wiE0zylvQTEbA>).
- **Concentrated ironGEL™ Part B:** This component, identical to the concentrated gel used in ZVI-ironGEL™, is packaged separately and can create a ZVI slurry containing 45-micron ZVI at 53.1 g/L.
- **ISR-CI:** A liquid iron-based reagent mirroring the natural biogeochemical reduction of solvents in aquifers. This product swiftly establishes conditions conducive to abiotic and biotic activity, facilitating the degradation of chlorinated ethenes, ethanes, and the precipitation of toxic metals. With an oxidation-reduction potential (ORP) ranging from -700 to -1,300 mV, injecting this liquid iron sulfide solution offers enhanced subsurface distribution, even in situations with lower permeability.



Product Portfolio & Capabilities Statement

3.1.3 Surfactant-Enhanced Aquifer Remediation (SEAR)

Surfactant-enhanced aquifer remediation (SEAR) stands as a cost-effective alternative to traditional pump-and-treat methods for remediating aquifers tainted by non-aqueous phase organic liquids. Tersus holds the global distribution rights for the foremost surfactant technology, TASK™ (Tersus Advanced Surface Kinetics), and associated products, encompassing techniques for *in situ* surfactant application and chemical oxidation. Benefiting from nearly two decades of research and testing conducted at the University of Oklahoma, TASK™ presents a versatile array of applications specifically tailored to hydrocarbon contamination flushing.



LNAPL SEAR Project: Injection of 260,000 gallons TASK™ ASB/polymer formulation, followed by 780,000 gallons of water, and recovery of same with LNAPL.

TASK™
(Tersus Advanced Surface Kinetics)
liberates NAPL and captures them
with enhanced recovery techniques.

TASK™ ASB (Anionic Surfactant Blend): An optimized surfactant formulation that will simultaneously produce an ultra-low NAPL/groundwater interfacial tension and minimize the amount of surfactant required (typically 0.9% by weight surfactant). The formulation maximizes mobilization of NAPL in the aquifer, while also producing

only fast breaking NAPL/groundwater emulsions that can be broken easily on the surface, reducing off site waste disposal and increasing the opportunity to recycle the recovered NAPL.

3.1.4 In Situ Chemical Oxidation (ISCO)

ISCO is a remediation approach involving the direct injection or introduction of potent chemical oxidizers into contaminated soil or groundwater to effectively eliminate chemical contaminants on-site. The selection of the oxidant depends on factors such as the target contaminant, pH, alkalinity, and the presence of sensitive receptors.

Tersus specializes in utilizing two main chemical oxidants: a modified Fenton's reagent and persulfate. Through collaborative efforts with clients, Tersus offers expertise in determining the most suitable oxidant(s) for a specific site. Additionally, Tersus assists in calculating the required oxidant load and conducts Total Oxidant Demand (TOD) testing, considering dissolved contaminants, adsorbed contaminants, free-phase contaminants, dissolved and solid-phase reduced minerals, and naturally occurring organic material.

Our advanced suite of ISCO products includes:

- **TersOx™ Modulator:** A surfactant-based hydrogen peroxide stabilizer. Co-injected with hydrogen peroxide, it gradually generates hydroxyl free radicals, reducing oxygen demand, eliminating high contaminant inhibition, and enhancing bioremediation performance by directing biological activity towards contaminant breakdown.
- **TersOx™ - NPS (Sodium Persulfate):** The strongest oxidant within the peroxygen family for in situ remediation of volatile and semi-volatile organic compounds. Activating NPS with heat or a base generates sulfate radicals, highly reactive and effective in degrading organic compounds in water or soil through oxidation reactions.

Product Portfolio & Capabilities Statement

Activation Mechanisms:

Activating persulfate with heat initiates advanced oxidation processes, breaking the peroxysulfate bond and forming sulfate radicals:

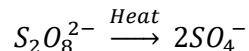

Activating persulfate with a base (TersOx™ Buffer NaOH or TersOx™ Powder) involves the following mechanism:

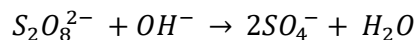

The sulfate radicals formed during thermal and base activation are potent oxidants, initiating the degradation of volatile and semi-volatile organic compounds through oxidation reactions, ultimately producing smaller, less harmful byproducts.

3.1.5 Enhanced Anaerobic Oxidative Bioremediation

Enhanced anaerobic bioremediation encompasses two main types: reductive, a well-established technology primarily utilized for treating chlorinated compounds, and oxidative, employed in the remediation of petroleum hydrocarbons.

Oxidation serves as the primary metabolic pathway for the biodegradation of petroleum hydrocarbons. This process involves the transfer of electrons from the petroleum hydrocarbon (an electron donor) to another compound known as an electron acceptor. Anaerobic oxidation occurs when compounds like sulfate act as electron acceptors. The availability of sulfate often limits the naturally occurring biodegradation of petroleum hydrocarbons. Nevertheless, it is feasible to accelerate natural biodegradation rates by supplementing additional sulfate (i.e., Nutrisulfate®) and nutrients (i.e., TersOx™ Nutrients-QR) to the subsurface microbial community.

Nutrisulfate® stimulates biodegradation by providing a high-sulfate metabolic supplement designed to enhance the kinetics and efficiency of microbial systems specifically tailored for the bioremediation of BTEX, MTBE, TBA, and other petroleum hydrocarbons. Following the revitalization of previously limited sulfate levels, anaerobic groundwater bacteria utilize petroleum hydrocarbons for carbon and energy, ultimately mineralizing the hydrocarbons into carbon dioxide and water.

Nutrisulfate® is a high sulfate metabolic supplement designed to enhance the kinetics and efficiency of microbial systems specifically related to anaerobic oxidation of BTEX, MTBE, TBA and other petroleum hydrocarbons. The increase in kinetics and efficiency decreases remediation times and reduces the amount of substrate/ amendment required.

Nutrisulfate® is suitable for easy injection and distribution. It poses no adverse effects, presenting a clean, cost-effective, and non-disruptive application for direct-push points and injection wells.

Product Portfolio & Capabilities Statement

3.1.6 In Situ Sorption and Biodegradation (NutriBind®)

By combining powdered activated carbon with an electron acceptor to induce biodegradation, NutriBind® is meticulously formulated to address the inherent challenges in soil and groundwater remediation. Serving as a potent powdered reagent, NutriBind® rapidly reduces contaminant concentrations upon application while concurrently expediting bioremediation processes.

NutriBind® facilitates biodegradation by supplying a soluble, readily available electron acceptor. In the presence of sulfate, anaerobic groundwater bacteria can efficiently utilize BTEX, MTBE, and other petroleum hydrocarbons for carbon and energy, ultimately mineralizing these compounds into carbon dioxide and water. The addition of sulfate augments natural processes and presents a more environmentally friendly solution with a lower carbon footprint compared to conventional remediation techniques.

The metabolic supplements within NutriBind® significantly enhance the kinetics and efficiency, thereby reducing the remediation time of sulfate-reducing microbial systems associated with the biodegradation of BTEX, MTBE, TBA, and other petroleum hydrocarbons.

3.1.7 Enhanced Aerobic Biodegradation

TersOx™ Powder is a crafted calcium peroxide formulation engineered for the purpose of delivering a controlled release of molecular oxygen. Tailored to support aerobic bioremediation efforts in both soil and groundwater, TersOx™ Powder plays a pivotal role in fostering the natural degradation of hydrocarbons.

Specifically designed for the breakdown of petroleum hydrocarbons, TersOx™ Powder stands out as a catalyst for the enhancement of bioremediation processes.

Unlike chemical oxidation products, TersOx™ Powder harnesses its high oxygen content, exceeding 16.6% by weight, to establish a sustained oxygen supply lasting up to 12 months under optimal conditions.

The protracted release of oxygen not only acts as a continuous energy source but also serves as a catalyst for indigenous bacteria, ultimately expediting bioactivity. This synergistic approach facilitates a more efficient and thorough removal of contaminants.



Product Portfolio & Capabilities Statement

3.1.8 Nutrients and Microbes

TersOx™ Nutrients-QR is designed for both *in situ* and *ex situ* bioremediation of organic contaminants in soil and groundwater. This cost-effective and user-friendly product offers an efficient pathway to eliminate constituents of concern, addressing the inherent deficiencies of nitrogen and phosphorus in contaminated matrices—essential elements for microbial activities during the destruction of organic contaminants.



TersOx™ Nutrients-QR stands out as a specialized blend, incorporating nitrogen, phosphorus, and microbial growth enhancers meticulously combined to stimulate biological activity within soil and groundwater. By delivering a distinctive and well-balanced mix of limiting nutrients, TersOx™ Nutrients-QR significantly amplifies the rate and consistency of the biological degradation process in various contaminated matrices.

For enhanced reductive dechlorination projects, it is important to note that Kaya et al., 2019 found that biostimulation benefits from adding an exogenous nitrogen (N) source (e.g., NH_4^+). It is reported in Environ. Sci. Technol. 2019, 53, 24, 14548–14558 that the addition of NH_4^+ increased cis-1,2 dichloroethene (cDCE)-to-ethene dichlorination rates about 5-fold.

TersOx™ Nutrients-DAP is a yeast and groundwater bioremediation nutrient to enhance aerobic processes. Contaminated matrices are usually deficient in nitrogen and phosphorus content, key elements in biological activities during microbial destruction of organic contaminants. Using TersOx™ Nutrients-DAP provides limiting nutrients and biodegradation rates are maximized.

Nutrimens® Yeast provides a source of B-complex vitamins, proteins, amino acids, and minerals to enhance aerobic processes.

TersOx™ Microbe is an advanced solution, meticulously crafted as a synergistic blend of specifically selected and adapted microorganisms to address a diverse array of bioremediation challenges. Tailored for optimal effectiveness, it is designed to tackle issues arising from petroleum hydrocarbon spillage, petrochemical contamination, and related waste concerns.

Specially formulated to combat problems associated with crude petroleum, gasoline, diesel fuel, machining oils, hydraulic fluids, solvents, and other petroleum derivatives, TersOx™ Microbe stands out for its versatility and efficiency. Its unique composition integrates preselected and adapted microbial strains, each possessing enhanced hydrocarbon-degrading capabilities.

TersOx™ Microbe promotes the efficient breakdown of oily and chemical mixtures at a nominal cost. This cutting-edge formula is a result of combining aerobic and facultative anaerobic microorganisms carefully chosen from nature. These microorganisms are renowned for their exceptional ability to break down a wide spectrum of wastes originating from petroleum recovery, transportation, storage, refining, steelmaking, metal forming, textile production, as well as hydrocarbon and chemical processing.

Product Portfolio & Capabilities Statement

3.2 Services

3.2.1 Design and Implementation Support

Achieving success in implementation on an *in situ* remediation project demands meticulous, goal-oriented planning. There is no substitute for the invaluable input of a team of qualified professionals to guide you in achieving on-time and on-budget site closure.

Tersus collaborates with clients to precisely dose our products and devise project designs. Our team of engineers, scientists, and support personnel is ready to join forces with you on your *in situ* remediation projects. Choosing Tersus to support your field effort enhances the likelihood of success while minimizing the risks associated with managing complex soil and groundwater remediation projects.

3.2.2 Environmental Forensics and Performance Monitoring

Tersus stands as a trusted partner, acknowledged by environmental consultants, site owners, regulators, and government agencies for their soil and groundwater remediation needs. The company's scope has expanded, now offering consulting services for environmental forensics and performance monitoring through compound-specific isotope analysis (CSIA). CSIA is an analytical method that measures the ratios of naturally occurring stable isotopes (e.g., $^{13}\text{C}/^{12}\text{C}$, $^2\text{H}/^1\text{H}$, or $^{37}\text{Cl}/^{35}\text{Cl}$) in environmental samples. This characterization tool proves valuable for demonstrating *in situ* destruction of selected VOCs and conducting forensic investigations to gather information about potential contaminant sources, the extent of degradation, commingling of contaminant plumes, and the origins of certain chemicals.

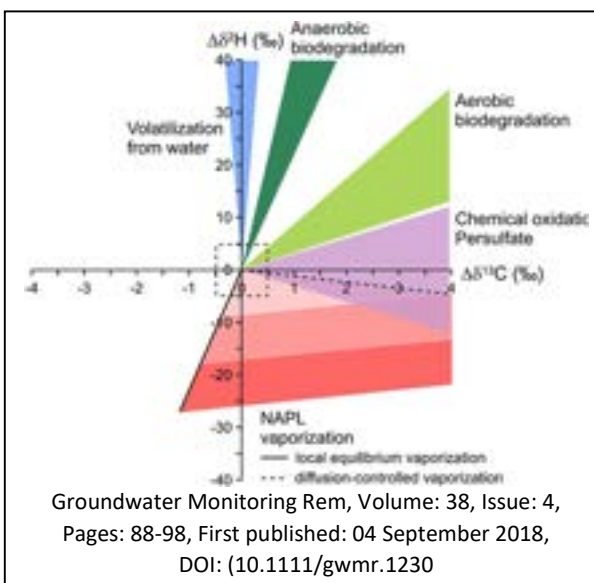

3.2.3 SEAR Treatability Studies

Through collaborative university partnerships, Tersus conducts laboratory treatability studies. Tersus customizes surfactant systems for the unique geochemistry and non-aqueous phase liquid (NAPL) characteristics of each site. The treatability study encompasses phase behavior studies to pinpoint the optimum salinity for achieving ultra-low interfacial tension (IFT), facilitating NAPL mobilization through capillary displacement. Additionally, the service includes surfactant/groundwater and surfactant/soil interaction studies to ensure the surfactant system remains active under aquifer conditions. Ultimately, column tests are conducted to determine the optimal injection strategy and the required volumes for post-surfactant recycled groundwater injection.

Product Portfolio & Capabilities Statement

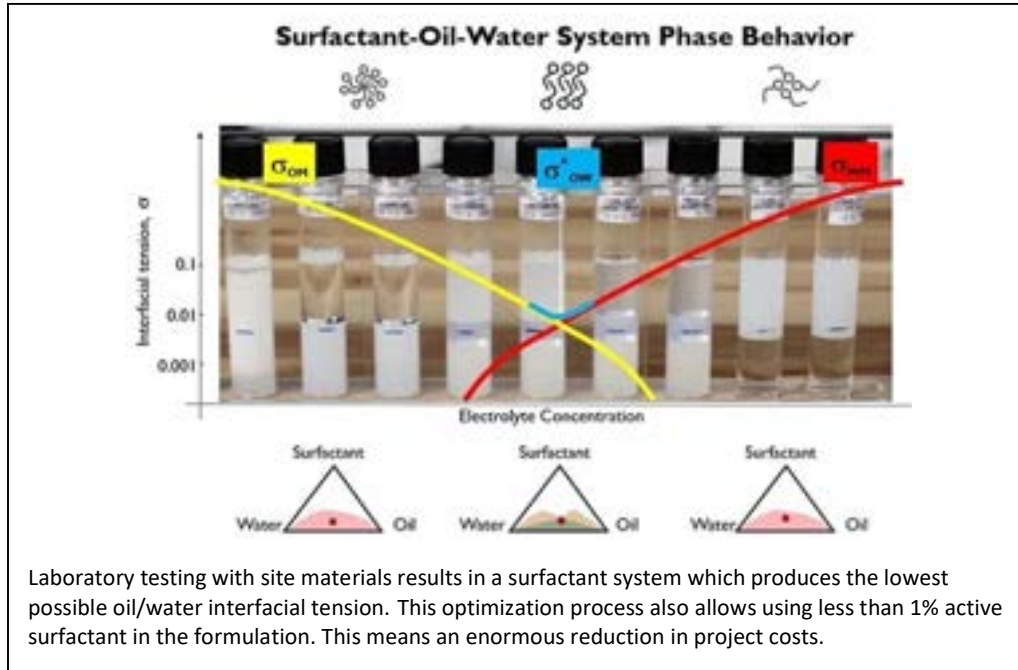

4. Product Distribution Centers / Warehouse Facilities

Tersus maintains stock at third-party logistic warehousing facilities strategically located in California, Illinois, North Carolina, Wisconsin, and France.



5. Project Showcases: A Track Record of Success

In Section 5 of this Product Portfolio & Capabilities Statement, we present case studies that underscore our commitment to pioneering environmental solutions. Detailed project descriptions can be found in Appendix A, offering comprehensive insights into the application and success of our advanced remediation technology in addressing complex challenges associated with chlorinated solvents in groundwater.

Product Portfolio & Capabilities Statement

To illustrate the potential scope of our projects, Tersus has provided three *in situ* case studies. These include:

- Enhanced Reductive Dechlorination (ERD) in São Paulo, Brazil
- ERD coupled with *In Situ* Chemical Reduction (ISCR) in Pennsylvania
- Catalyzed Enhanced Reductive Bioremediation coupled with ISCR in Kansas

The Kansas project stands out for its implementation of Catalyzed Enhanced Reductive Bioremediation coupled with ISCR, a groundbreaking approach employed by Tersus for the targeted treatment of chlorinated solvents in groundwater.

Currently, Tersus is conducting a pilot study to evaluate Heat-Enhanced Catalyzed Reductive Bioremediation. The synergy between Heat-Enhanced Catalyzed Reductive Bioremediation and ISCR represents a pinnacle in our remediation methodologies, showcasing innovation, efficiency, and a steadfast dedication to environmental sustainability.

6. Leadership Team: Background and Experience

In Section 6 of the Statement of Qualifications, we present an overview of our leadership team and driving the success of Tersus. Our team is led by Gary M. Birk, P.E., the Founder and Managing Partner, whose distinguished career spans 40 years and has left an indelible mark on the environmental remediation industry.

Supporting Gary is David F. Alden, P.E., MSc., the Manager of Technical Services. David brings a wealth of expertise in environmental engineering, bolstered by his diverse academic background and extensive industry experience. His contributions play a pivotal role in driving Tersus' innovative solutions forward.

Featured Project

Travis AFB's Winning Solution Combines Cost Savings & Sustainability

Travis Air Force Base's Sustainable Groundwater Treatment Program (GWTP), utilizing Tersus EDS-ER™, successfully achieved the dual objectives of cost savings and environmental protection. Deploying EDS-ER™ resulted in cost savings exceeding \$250,000 annually and a substantial annual reduction of approximately 930 tons of carbon dioxide emissions – equivalent to removing 200 cars from the road.

Lonnie Duke, Restoration Program Manager highlighted the integral connection between Green and Sustainable Remediation (GSR) and the expedited cleanup of contaminated sites, accompanied by significant cost reductions. The program's effectiveness is evident in achieving a 99 percent cleanup rate for high concentrations of chlorinated solvents in some source areas. Furthermore, the cleanup timeframe for multiple sites has been drastically reduced by several decades.

For the full article detailing Travis Air Force Base's prestigious wins, please visit: <https://qrs.ly/52fldrj>.



Product Portfolio & Capabilities Statement

Complementing the leadership team is Sherri Scott, who serves as the Manager of Business Development for the U.S. Sherri is dedicated to fostering exceptional customer care and spearheading strategic business development initiatives, making her an invaluable asset to Tersus.

Together, our leadership team embody the commitment to sustainable and effective solutions, driving our mission to address complex environmental challenges with innovation and expertise. Biographies for Gary M. Birk, P.E., David F. Alden, P.E., MSc., and Guilherme “William” M. Figueiredo, MSc. highlighting key aspects of their education, career, and achievements follow.



Gary M. Birk, P.E. (NC, VA, & FL)
Founder and Managing Partner

Gary is a distinguished figure in the environmental remediation industry, serving as the Founder and Managing Partner of Tersus Environmental, LLC, headquartered in North Carolina. Additionally, he holds the position of Director at Tersus Environmental Limited, based in Ireland. Armed with a bachelor's degree in chemical engineering from North Carolina State University, Gary boasts registrations as a Professional Engineer in North Carolina, Virginia, and Florida, reflecting his commitment to excellence and regulatory compliance.

With an impressive career spanning 40 years, Gary has been at the forefront of developing and implementing cutting-edge technologies for *in situ* remediation of contaminated soil and groundwater. His expertise extends globally, having undertaken projects in North America, South America, Europe, Asia, and Africa. Gary's passion lies in leveraging sustainable green technologies to address environmental challenges, particularly in groundwater and soil restoration.

A pioneer in the field of bioremediation and environmental consulting, Gary commercialized EDS-ER™ in 2011, a groundbreaking water-mixable vegetable oil-based organic substrate. This product has become widely recognized as a lasting source of carbon and hydrogen for enhanced reductive dechlorination and various bioremediation processes. Gary's influence extends beyond product development; he is the author of Design Tools for *in situ* bioremediation, contributing significantly to advancing industry standards in estimating substrate application rates.

Gary's intellectual contributions are underscored by his authorship of four U.S. Patents related to reductive bioremediation and *in situ* chemical reduction of soil and groundwater. Notably, he is the lead author of US Patent 11,577,231 B2, titled "Enhanced Reduction Bioremediation Method Using In-Situ Alcoholysis." This patent demonstrates his innovative approach, focusing on transesterification of vegetable oils to enhance the formation and distribution of crucial electron donors for anaerobic reductive bioremediation. Beyond his accomplishments, Gary has eight pending patent applications, solidifying his commitment to pushing the boundaries of remediation technologies for groundwater contaminants.

Product Portfolio & Capabilities Statement



David F. Alden, P.E. (NC), MSc.
Manager, Technical Services

David serves as the Manager of Technical Services at Tersus Environmental, where he is a dedicated professional with extensive experience in environmental engineering and technical services. In this pivotal role, David is instrumental in fostering innovation and excellence within the realm of environmental solutions. He provides crucial technical support for Tersus' biotechnology-based solutions, specializing in the management of complex environmental liabilities and cost reduction for site closure.

David's academic journey includes earning a degree in Civil Engineering from Universidad de las Americas-Puebla, Mexico, and a master's degree from Joseph Fourier University in Grenoble, France. With this diverse educational background, he brings a unique perspective to his position.

Having spent four years in the upstream oilfield sector, David contributed significantly to offshore well tests and completion design and installation in the Gulf of Mexico. His expertise extends to *in situ* oil-shale extraction experiments in the Piceance Basin, Northwestern Colorado, with a primary focus on safeguarding groundwater.

A key aspect of David's work revolves around the development of innovative technologies for restoring groundwater and soil in challenging sites. He has authored three patents on reductive bioremediation and *in situ* chemical reduction, with US Patent 11,123,779 B2 titled "Method and a Chemical Composition for Accelerated *In Situ* Biochemical Remediation" being a notable contribution. Additionally, he has eight pending patent applications for groundwater contaminant remediation.

Managing the companies Compound-Specific Isotope Analysis (CSIA) projects, David showcases his commitment to staying at the forefront of industry advancements by applying cutting-edge techniques to assess environmental contaminants. David leverages his expertise in CSIA to provide a quantitative means for differentiating reaction pathways—shedding light on the intricate processes of abiotic and biotic degradation. This not only enhances our understanding of environmental challenges but also paves the way for more targeted and effective solutions.

David also employs molecular biologic tools to assess remediation performance. By integrating cutting-edge techniques, he ensures that our environmental solutions are not only efficient but also sustainable in the long run.

Beyond his professional accomplishments, David actively engages in community initiatives focused on environmental awareness and sustainability. His multifaceted background and dedication to finding sustainable solutions position him as a thought leader in the environmental engineering field. David's comprehensive experience, innovative approach, and unwavering commitment make him a driving force behind Tersus Environmental's mission to provide sustainable and effective solutions to complex environmental challenges.

Product Portfolio & Capabilities Statement

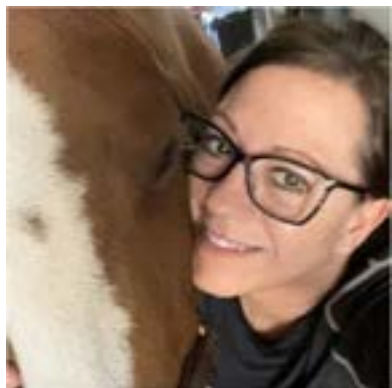

Sherri Scott
Manager, U.S. Business Development

Sherri Scott serves as the Manager of Business Development for the U.S. region at Tersus, overseeing operational and strategic marketing, as well as fostering customer relationships. Transitioning from a paralegal background to sales, Sherri brings a unique blend of skills to her role, marked by her exceptional drive, positivity, and self-motivation.

With a career spanning various roles, Sherri has a wealth of experience, including managing escalated customer complaints for IBM's Chairman's office, often involving complex litigation. This experience has honed her understanding of the delicate balance required in business relationships. Sherri's approach prioritizes relationship-building, ensuring a foundation of trust before pursuing sales opportunities.

Drawing on her diverse background in sales, customer care, and legal support, Sherri consistently demonstrates a strong work ethic and a talent for driving results. She is dedicated to creating positive impacts through collaboration and partnership, aligning organizational goals with a shared vision.

Based in the Carolinas, Sherri is actively involved in supporting the South Carolina Association of Environmental Professionals, where she served as Past President. She takes great pride in delivering exceptional customer care and driving overall business development efforts, believing in the power of teamwork and unified goals.

7. Intellectual Property (Tersus Assigned Patents and Trademarks)

We take pride in our robust foundation of intellectual property, a testament to our commitment to innovation in environmental remediation. Our portfolio includes several noteworthy patents that underscore our expertise and advancements in the field. These patents exemplify our dedication to pioneering solutions in the realm of soil and groundwater remediation and include:

- [US 11,577,231 B2](#), Enhanced reduction bioremediation method using in-situ alcoholysis (Gary M. Birk, P.E. and David F. Alden, P.E.) February 14, 2023
- [U.S. Patent No. 11,123,779 B2](#), Method and a Chemical Composition for Accelerated In Situ Biochemical Remediation, Alden Et al. (David F. Alden, P.E.; Gary M. Birk, P.E.; Sangho Bang, Ph.D.; Jeffrey H. Harwell, Ph.D.; and Bor Jier Shiau, Ph.D.) November 8, 2022
- [U.S. Patent 11,491,522 B2](#), Zero-Valent Metal Suspension in Non-Aqueous Phase for Water Remediation, Bang Et al. (Sangho Bang, Ph.D.; David F. Alden, P.E.; Gary M. Birk, P.E.; Jeffrey H. Harwell, Ph.D.; and Bor Jier Shiau, Ph.D.) September 21, 2021.
- [U.S. Patent No. 9,309,136 B2](#), Bioremediation of Soil and Groundwater, John Archibald and Gary M. Birk, April 12, 2016
- [U.S. Patent No. 7,708,496 B2](#), *In-Situ Surfactant and Chemical Oxidant Flushing for Complete Remediation of Contaminants and Methods of Using Same*, Shiau, Bor-Jier, May 4, 2010
- [U.S. Patent No. 7,677,836 B2](#), *In-Situ Surfactant and Chemical Oxidant Flushing for Complete Remediation of Contaminants and Methods of Using Same*, Shiau, Bor-Jier, March 16, 2010
- [U.S. Patent No. 7,364,386 B2](#), *In-Situ Surfactant and Chemical Oxidant Flushing for Complete Remediation of Contaminants and Methods of Using Same*, Shiau, Bor-Jier, April 29, 2008

Product Portfolio & Capabilities Statement

- [U.S. Patent No. 7,021,863 B2](#), *In-Situ Surfactant and Chemical Oxidant Flushing for Complete Remediation of Contaminants and Methods of Using Same*, Shiau, Bor-Jier, April 4, 2006
- [U.S. Patent No. 6,913,419 B2](#), *In-Situ Surfactant and Chemical Oxidant Flushing for Complete Remediation of Contaminants and Methods of Using Same*, Shiau, Bor-Jier, July 5, 2005

Embarking on a journey of innovation and excellence, our extensive portfolio not only includes groundbreaking patents but also encompasses distinctive trademarks that underscore our commitment to quality and expertise in environmental solutions. These trademarks serve as symbolic representations of our dedication to delivering exceptional products and services in the realm of soil and groundwater remediation. As we proudly present our intellectual property, it reflects not just our achievements but also our ongoing pursuit of cutting-edge solutions that redefine the landscape of environmental remediation.

Registered US Trademarks	Trademarks	
<ul style="list-style-type: none"> • NutriBind® • Nutrimens® • Nutrisulfate® 	<ul style="list-style-type: none"> • EDS-Activator™ • EDS-Advanced™ • EDS-ER™ • EDS-ME™ • EDS-QR™ 	<ul style="list-style-type: none"> • EDS-ZVI™ • MicroEVO™ • NanoEVO™ • TASK™ • TersOx™

8. Insurance

Tersus currently maintains and commits to maintaining, throughout the term of this Agreement, Workers Compensation/Employer's Liability, Comprehensive General, Contractual Liability, and Comprehensive Automobile Liability Insurance in the specified amounts outlined in the table below:

	Occurrence limit	Aggregate limit
Commercial General Liability	\$1,000,000	\$2,000,000
Contractors Pollutions Liability	\$1,000,000	\$2,000,000
Professional Liability	\$1,000,000	\$2,000,000
Umbrella / Excess Liability	\$1,000,000	\$1,000,000
Automobile Liability	\$1,000,000 Combined Single Limit (Each Accident)	
Workers Compensation and Employers' Liability	\$1,000,000	

9. Safety

In our commitment to safety excellence, Tersus ensures that all personnel visiting project sites possess OSHA 40-hour HAZWOPER certification and undergo regular medical monitoring. Our safety program is designed to uphold the standards in environmental health and safety practices.

Product Portfolio & Capabilities Statement

10. Working with Us

Since 2011, Tersus Environmental has established itself as a reliable partner for environmental consultants, site owners, regulators, and government agencies, addressing their soil and groundwater remediation needs. Our exclusive focus is on serving environmental consultants and contractors, ensuring that Tersus becomes an integral part of your Project Team. By choosing Tersus, you enhance the probability of project success while effectively managing the risks associated with intricate soil and groundwater remediation projects.



Request a Site Evaluation and Cost Estimate

Are you considering a Site Evaluation? Tersus Environmental specializes in providing technical solutions for challenges encountered by the soil and groundwater remediation community. Our commitment involves offering technical expertise across various technologies, without being tied to a single solution. Our dedicated Technical Services Team, comprised of highly experienced remediation professionals, manages this complimentary service. Rest assured that all information shared will be treated with the utmost confidentiality.

To make the most of this service, kindly provide the necessary site information by following these steps:

1. [Downloading](http://www.thersusenv.com/images/site/sef/SEF - General.docx) our Site Evaluation Form in MS Word format (www.thersusenv.com/images/site/sef/SEF - General.docx)
2. Completing the required information and saving your changes.
3. Gathering additional documents such as maps, boring logs, etc.
4. Emailing the completed form and attachments to info@thersusenv.com.

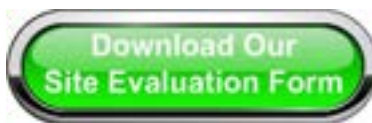

www.thersusenv.com/images/site/sef/SEF - General.docx

Don't worry if you don't have all the information we request initially; we will reach out to you to confirm details and ensure a thorough evaluation.

Product Portfolio & Capabilities Statement

one
to
one

Do you have questions or are you eager to explore some ideas? Engaging in a One-to-One session with your local Technical Sales Representative is the optimal way to delve into the details of our technologies. To schedule a personalized session, reach out to Sherri Scott to coordinate based on your schedule.

Sherri Scott | Manager, Business Development (US)
Direct 919.453.5577 #2003 | Mobile 919.527.9781
sherri.scott@tersusenv.com

11. Contact

Thank you for your interest in Tersus Environmental. Feel free to call us directly or send us a message using the email below. We look forward to hearing from you.

Tersus Environmental, LLC

1116 Colonial Club Road
Wake Forest, NC 27587 United States

+1 919-453-5577 | info@tersusenv.com

Statement of Qualifications

Appendix A

Case Studies



PROJECT SUMMARY

Location: Capuava, Maúá, São Paulo, Brazil

Client: Confidential Client

Project Practice Areas: Enhanced *In Situ* Reductive Dechlorination was employed for the groundwater remediation of chlorinated solvents (PCE and their byproducts). Project's end goal was to biostimulate endogenous *Dehalococcoides spp.* and *Dehalogenimonas spp.* microbial populations.

Project Duration and Year Completed:

2017 – Pilot Field Test

2018 to 2021 – Full Scale Remediation

2021 to 2022 – Source Area Additional Remediation

2022 – Cleanup Goals Achieved

2023 to 2026 – Post Remediation

Groundwater Monitoring Program

Area and Remediation Volume:

Treatment Area: 26,860 m²

Remediation Volume: 115,444 m³

Approximate Project Cost (Tersus)

\$100,000

REGULATORY AGENCY AND PROGRAM

CETESB – Companhia Ambiental do Estado de São Paulo (São Paulo's State Environmental Agency)

STAFF THAT WORKED ON PROJECT

Gary M. Birk, P.E

David F. Alden, P.E., MSc.

Tersus Environmental, LLC

+1 919-453-5577 • info@tersusenv.com

tersusenv.com • surbec.com

Bioremediation of Chlorinated Volatile Organic Compounds (cVOCs) in Groundwater

GENERAL APPROACH AND DESCRIPTION OF REMEDY

The approach involved the consideration of seven different injection zones with 4-inch injection wells ranging from 7 to 15 meters in depth, including a 1.5-meter screened section. At full scale, the injection system demonstrated an operational capacity of 80 m³ per day across 98 operating injection wells.

On-site, a Permeable Reactive Barrier was installed and operated, featuring 22 x 2-inch injection wells ranging from 9 to 28 meters in depth.

The chosen remedy for this project was a field mixture of Emulsified Vegetable Oil at a concentration of 2 to 4% v/v, sourced locally. Tersus provided the emulsifier TASK™ MicroEVO Self-Emulsifier for the entire remediation scope.

In addition, a locally sourced potassium bicarbonate buffering agent was injected with the remedy, following Tersus' recommendation to maintain ideal geochemical conditions for Enhanced Reductive Dechlorination.

GENERAL DESCRIPTION OF GEOLOGY AND HYDROGEOLOGY

The local site lithology is predominantly composed of late Quaternary sediments and fluvial deposits from the Tamanduateí River alluvial basin. It features alternating layers of fine to medium white and yellowish sand, as well as dark plastic organic clays.

MAXIMUM CONCENTRATION OF KEY CONTAMINANTS

Perchloroethylene (PCE) – 20,000 ppb (2017)

Trichloroethylene (TCE) – 55,000 ppb (2017/18)

1,2-Dichloroethylene (DCE) – 128,000 ppb (2019)

Vinyl Chloride (VC) – 250,000 ppb (2019)

PRESENCE OF DENSE NON-AQUEOUS PHASE LIQUID

No DNAPL was reported during baseline nor after treatment.

CLEANUP GOAL OR OBJECTIVE

Remediation Goals: 75% Mass Reduction in aggregated compounds (PCE, TCE, 1,2-DCE and VC) – Achieved in 2022

Remediation State's Thresholds – Achieved in 2022

PCE – 20 ppb, TCE – 10 ppb, 1,2-DCE – 5 ppb VC – 2 ppb

TERSUS ROLE ON PROJECT AND ROLE AND RESPONSIBILITY WITH RESPECT TO PROJECT DESIGN

Tersus played a pivotal role in the project by offering technical support for project execution, particularly in the realm of the involved remediation chemistry. Additionally, Tersus supplied the self-emulsifying agents, including the TASK™ MicroEVO Self-Emulsifier.

Statement of Qualifications

Appendix B

**Featured Project: Travis AFB's
Winning Solution Combines Cost Savings & Sustainability**



PROJECT SUMMARY

Location: Central PA, USA

Client: Confidential Client

Project Practice Areas: *In Situ* Chemical Reduction, combined with enhanced anaerobic bioremediation technologies, was employed for the groundwater remediation of chlorinated solvents at an industrial site. The remediation process involves injection through direct push injection points inside an operating facility.

Project Duration and Year Completed:

April 2019 – Baseline

June 2019 – 1st Injection Campaign

Area and Remediation Volume:

Treatment Area: 20,322 ft²

Remediation Volume: 1,266,012 ft³

Approximate Project Cost (Tersus)

\$100,000

REGULATORY AGENCY AND PROGRAM

Pennsylvania Department of Environmental Protection

STAFF THAT WORKED ON PROJECT

David F. Alden, P.E., MSc.

Gary M. Birk, P.E

Tersus Environmental, LLC
+1 919-453-5577 • info@tersusenv.com
tersusenv.com • surbec.com

Bioremediation and Chemical Reduction of Chlorinated Volatile Organic Compounds (cVOCs) in Groundwater

GENERAL APPROACH AND DESCRIPTION OF REMEDY

The executed scope involved considering four different injection zones using the Direct Push injection methodology to deliver both a micro-scale Zero-Valent Iron (ZVI) colloidal suspension and a water-mixable vegetable oil-based organic substrate (EDS-ER™) to the contaminated portions of the aquifer. The injection zones, numbered 1 through 4, consisted of 75, 12, 20, and 8 injection points, each with a 7.5 ft radius of influence, totaling 115 points.

All remediation products utilized in this project were procured from Tersus. For bioaugmentation products, Tersus collaborated with SiREM. The remediation products employed comprised: The remediation products utilized included:

- EDS-ER™, a long-lasting water-mixable vegetable oil-based organic substrate (electron donor) that provides a sustained source of carbon and hydrogen for enhanced reductive dechlorination and other bioremediation processes.
- A micro-scale Zero-Valent Iron (ZVI) colloidal suspension (mZVI™)
- EDS-QR™, a fast-acting, completely soluble amendment engineered for enhanced reductive dechlorination of chlorinated solvents or any other anaerobically degradable substance.
- KB-1®, a natural microbial consortium containing *Dehalococcoides spp.* bacteria that dechlorinate chlorinated ethenes to ethene.
- L-cysteine base, an amino acid to prepare anaerobic water to protect anaerobic bioaugmentation cultures during injection into aquifers.

The remediation approach aimed to introduce strong reductants into the contaminated medium to initiate the rapid destruction of chlorinated contaminants like PCE. Simultaneously, it sought to create an ideal environment conducive to microbial growth and stimulation for reductive dechlorination. The applied doses were 1.45g/L for mZVI™, 2.28 g/L for EDS-ER™, and 1.9 g/L for EDS-QR™.

GENERAL DESCRIPTION OF GEOLOGY AND HYDROGEOLOGY

The local site lithology is predominantly characterized by layers of silt and clay, with organic clayey lenses, and trace compartments of gravel and sand. The water table is confirmed to be around 6 feet below the ground surface (bgs). The thickness of the remediation treatment extends from 6 to 16 feet bgs, covering a total thickness of 10 feet.

MAXIMUM CONCENTRATION OF KEY CONTAMINANTS

April 2019 (Baseline)

Perchloroethylene (PCE) – < 1 ppb (Below Detection Limit)

Trichloroethylene (TCE) – 8 ppb

1,2-Dichloroethylene (DCE) – 21,000 ppb

Vinyl Chloride (VC) – 9,600 ppb

PRESENCE OF DENSE NON-AQUEOUS PHASE LIQUID

No DNAPL was reported during baseline nor after treatment.

Case Study

ERD and ISCR Central Pennsylvania

PERCENT REDUCTION OF KEY CONTAMINANTS

95% Aggregated Mass Reduction on Chlorinated Contaminants – PCE, TCE, 1,2-cis-DCE, and VC.

TERSUS ROLE ON PROJECT AND ROLE AND RESPONSIBILITY WITH RESPECT TO PROJECT DESIGN

Tersus played a crucial role in the project, which involved reviewing project data and formulating the project approach for the injection of amendments at the site. The scope of services provided by Tersus included:

- Specifying the types and quantities of amendments to inject at each location.
- Supplying the necessary amendments and injection equipment.
- Conducting on-site training sessions on both amendment mixing and injection procedures.
- Providing on-site training on the operation of injection equipment

Field Implementation

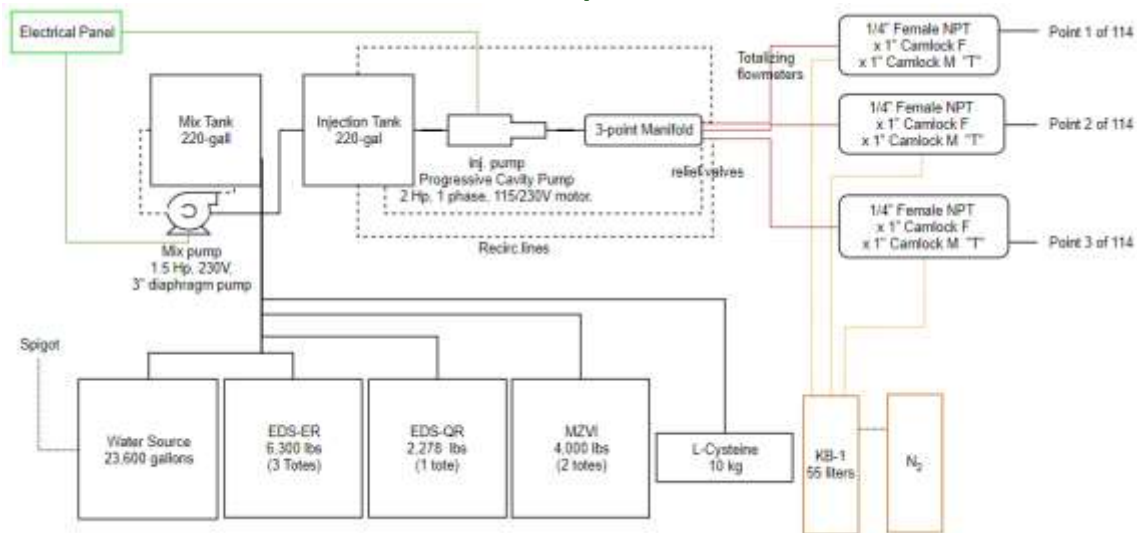

Injection Inside an Operating Facility With Space Constraints



ZVI suspension-two totes, EDS-ER™-three totes, EDS-QR™-one tote, L-Cysteine- two pails, KB-1® culture- 55L



Manifold Assembly and Pump



Mixing Pump



Injection Started

Statement of Qualifications

Appendix C

Tech Brief

Heat-Enhanced Catalyzed Reductive Bioremediation



PROJECT SUMMARY

Location: Wichita, KS, USA

Client: Confidential Client

Project Practice Areas: Long chain carbon tetrachloride and chlorinated solvents (PCE and byproducts) groundwater remediation through *In Situ* Chemical Reduction (ISCR) and *In Situ* Enhanced Reductive Dechlorination using a combination of a suspended solution of micro-scale Zero Valent Iron (ZVI), Emulsified Vegetable Oil, and pH buffers, nutrients, and a custom formulated natural microbial consortium *Dehalococcoides spp.* and *Dehalobacter spp.* (KB-1[®] Plus).

Project Duration and Year Completed:

August 2022 – Baseline

December 2022 – Pilot Test Injection

July 2023 – 1st Post Remediation

Groundwater Monitoring Campaign

Area and Remediation Volume:

Treatment Area: 540,000 square ft²

Remediation Volume: 3,240,000 ft³

Approximate Project Cost (Tersus)

\$130,000

REGULATORY AGENCY AND PROGRAM

Kansas Department of Health and Environment

STAFF THAT WORKED ON PROJECT

David F. Alden, P.E., MSc.

Gary M. Birk, P.E

Tersus Environmental, LLC

+1 919-453-5577 • info@tersusenv.com

tersusenv.com • surbec.com

Bioremediation and Chemical Reduction of Chlorinated Volatile Organic Compounds (cVOCs) in Groundwater

GENERAL APPROACH AND DESCRIPTION OF REMEDY

The scope of this project encompassed nine distinct injection zones, employing the direct push injection methodology to administer both a micro-scale Zero-Valent Iron (ZVI) colloidal suspension and EDS-Advanced™, a catalyzed enhanced bioremediation technology. The harmonious integration of Catalyzed Enhanced Reductive Bioremediation and ISCR marks a zenith in our remediation approaches, underscoring innovation, efficiency, and an unwavering commitment to environmental sustainability.

Within each of the injection zones, there were 48 injection points, each boasting a 7.5 ft radius of influence, culminating in a total of 304 points. All remediation products utilized in this project were procured from Tersus. For bioaugmentation products, Tersus collaborated with SiREM. The remediation products employed comprised:

- EDS-Advanced™ a catalyzed enhanced bioremediation technology that includes:
 - EDS-Substrate Shuttle™: This water-miscible solvent efficiently dissolves the vegetable oil, creating a solution with the distribution properties of a soluble electron donor.
 - EDS-Activator™: A homogeneous alkaline catalyst that promotes the formation of fatty acid alkyl esters, carboxylic acid salts, and glycerol (EDS-QR™).
 - TersOx™ Nutrients-QR: A specialty blend of nitrogen, phosphorus, and microbial growth enhancers to stimulate biological activity.
- ZVI-ironGEL™: A 45% ZVI colloidal suspension with a mean particle size of less than 10-micron, ZVI-ironGEL™ is optimized for injection at a 30 g/L ZVI concentration. The product incorporates environmentally friendly polymers engineered to create a viscoelastic gel, exhibiting shear-thinning behavior upon dilution with water. This gel ensures high colloidal stability, good injectability, and enhanced distribution in the subsurface
- KB-1[®] Plus is a custom formulated natural microbial consortium. For this application KB-1[®] Plus contained *Dehalococcoides* bacteria that dechlorinate chlorinated ethenes to ethene and *Dehalobacter* bacteria that dechlorinate Chloroform and dichloromethane to non-toxic end products.
- KB-1[®] Primer was used to rapidly prepare anaerobic injection water for bioremediation applications including dispersion of electron donors and protection of anaerobic bioaugmentation cultures during injection into aquifers.

The remediation strategy sought to introduce potent reductants into the contaminated medium, initiating the swift degradation of chlorinated contaminants such as Carbon Tetrachloride and PCE. In contrast, the design objective of the remediation was to establish a favorable and conducive environment for microbial growth and stimulation, facilitating reductive dechlorination.

GENERAL DESCRIPTION OF GEOLOGY AND HYDROGEOLOGY

The prevailing site lithology is primarily defined by the alternation of silty sand and clayey units, extending to a depth of 100 feet below ground surface (bgs). The water table is verified to be approximately 20 feet bgs. The extent of the remediation treatment spans from 26 to 32 feet bgs, encompassing a total thickness of 6 feet.

Case Study

ERD and ISCR Kansas

MAXIMUM CONCENTRATION OF KEY CONTAMINANTS

August 2022 (Baseline)

Carbon Tetrachloride (CTC) – 5,000 ppb
Chloroform (CF) – 50 ppb
Chloromethane (CM) – 5 ppb
Methylene Chloride (MC) – 10 ppb

Perchloroethylene (PCE) – 2 ppb
Trichloroethylene (TCE) – < 1 ppb
1,2-Dichloroethylene (DCE) – <1 ppb
Vinyl Chloride (VC) – 5 ppb 5074

PRESENCE OF DENSE NON-AQUEOUS PHASE LIQUID

No DNAPL was reported during baseline nor after treatment.

PERCENT REDUCTION OF KEY CONTAMINANTS

In August 2023 Post Pilot Scale Remediation Monitoring Campaign, approximately 98.5% aggregated mass reduction was achieved compared to the data observed on baseline.

August 2023 (Post Pilot Scale Remediation Monitoring Campaign)

Carbon Tetrachloride (CTC) – 50 ppb
Chloroform (CF) – 15 ppb
Chloromethane (CM) – <1 ppb
Methylene Chloride (MC) – 10 ppb

Perchloroethylene (PCE) – < 1 ppb
Trichloroethylene (TCE) – < 1 ppb
1,2-Dichloroethylene (DCE) – <1 ppb
Vinyl Chloride (VC) – < 1 ppb

TERSUS ROLE ON PROJECT AND ROLE AND RESPONSIBILITY WITH RESPECT TO PROJECT DESIGN

Tersus played a pivotal role in this project, undertaking crucial responsibilities such as reviewing project data, providing the client with technical expertise on optimal actions, and devising the project approach for the injection of amendments at the site. The range of services offered by Tersus encompassed:

- Clearly defining the types and quantities of amendments to be injected at each location.
- Providing the requisite amendments.
- Conducting training sessions on both amendment mixing and injection procedures.
- Monitoring performance through the use of molecular biological tools and compound-specific isotope analysis.